

# Schematic operating diagram

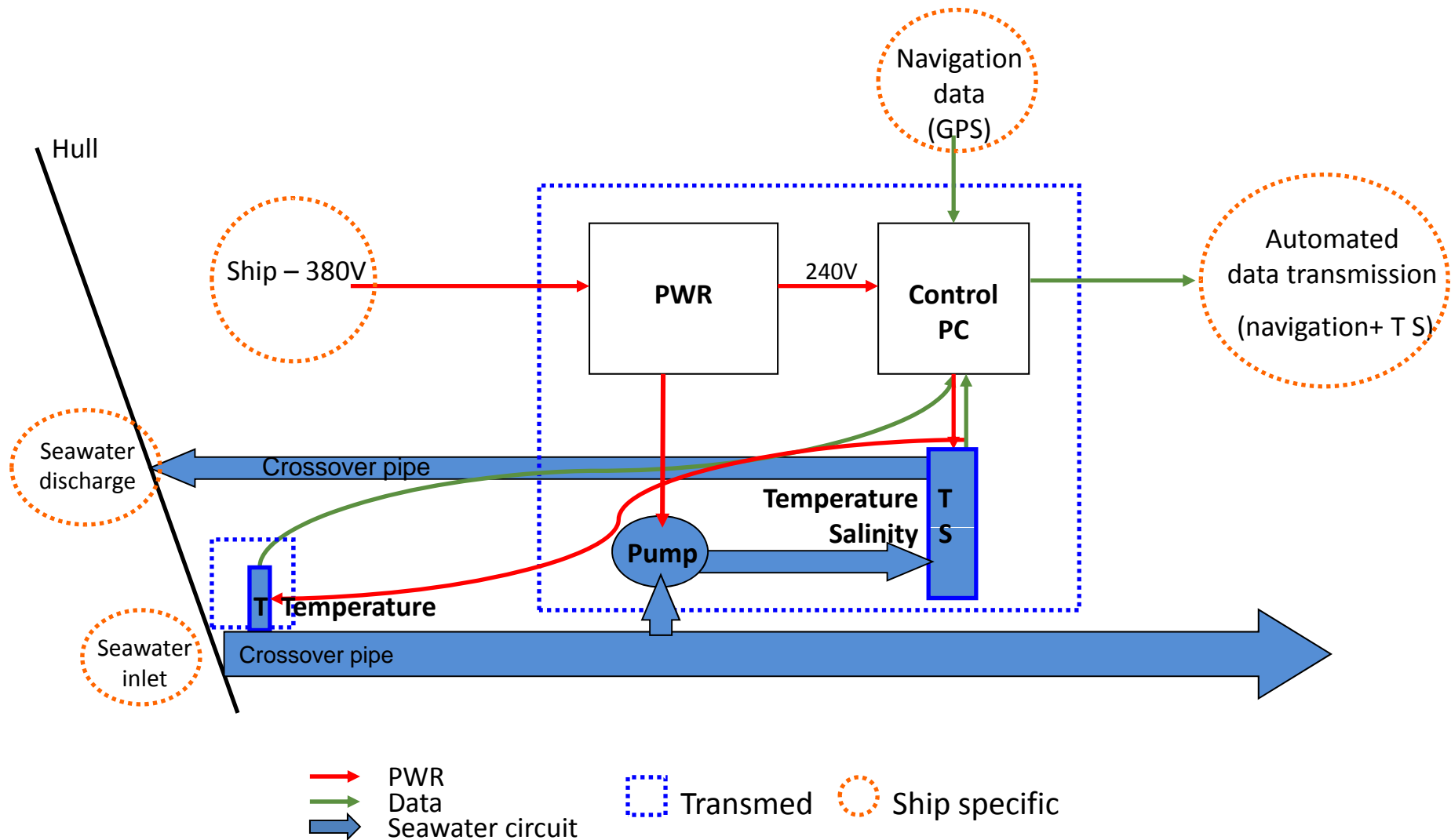

# Jolly Indaco /engine room 1

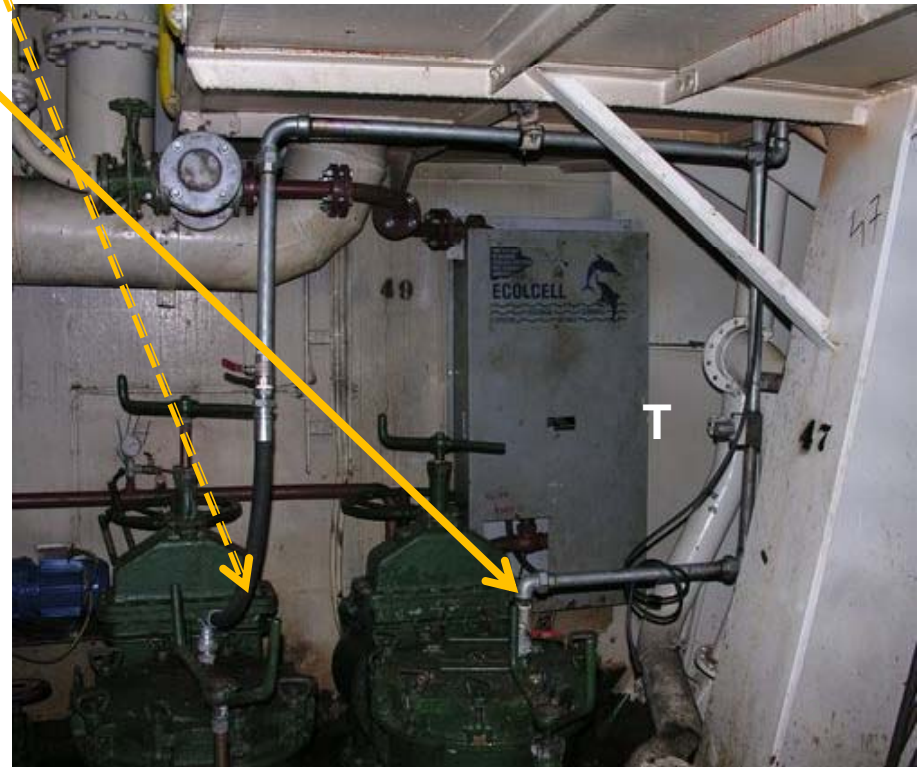
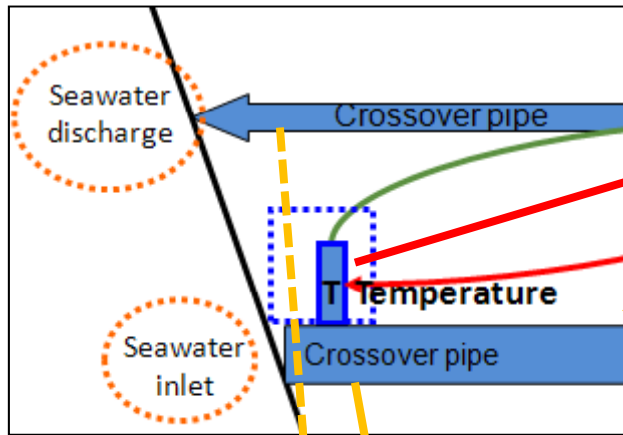

23/06/2011

Transmed

# Jolly Indaco /engine room 2

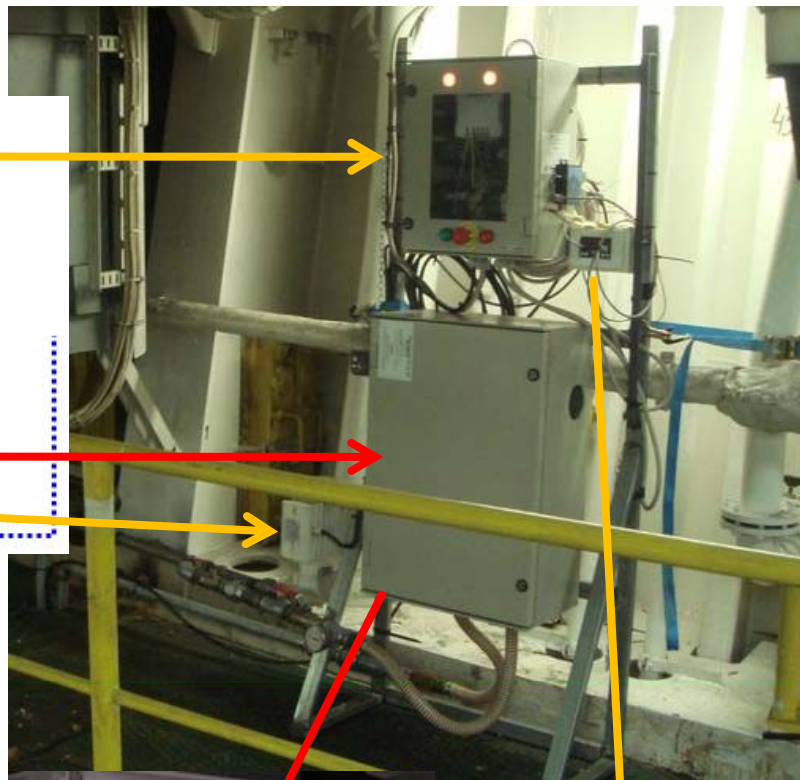
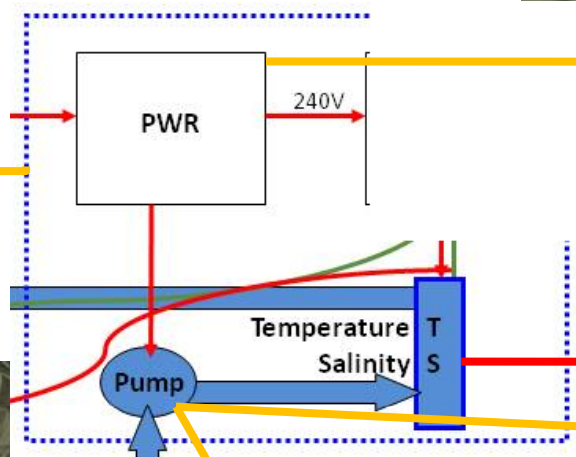

Transmed

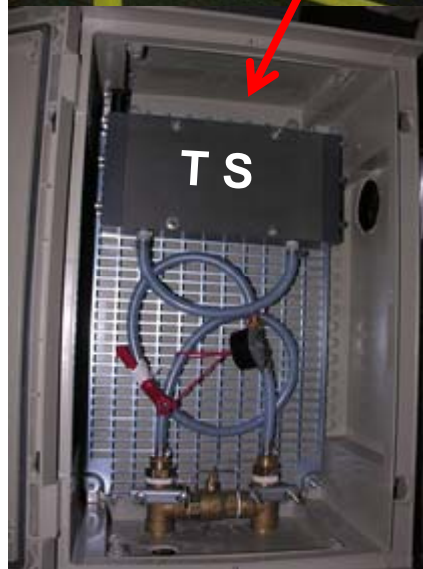

Network cabling

# Jolly Indaco /engine control room

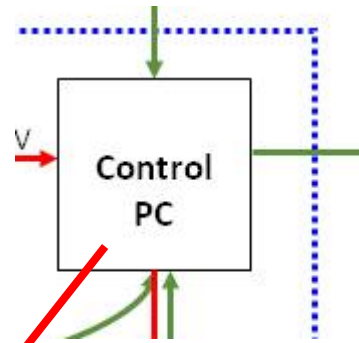

Jolly Indaco /

deck

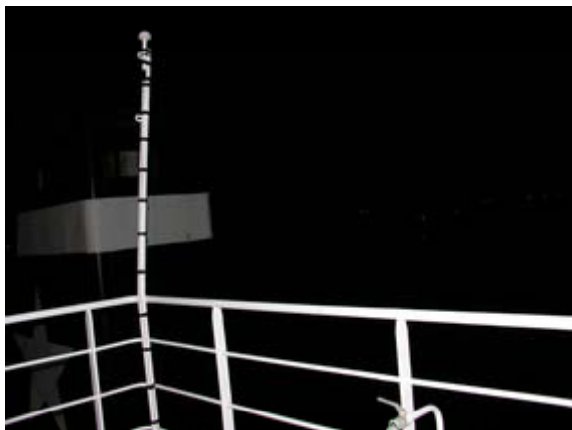

**GPS antenna and cabling to radio room**

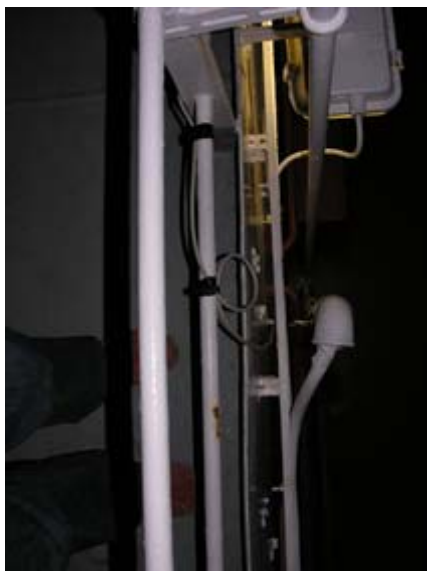

## Jolly Indaco / radio room

